

RF Balun Transformer HTW3593



50Ω 1:1.5 Transmission Line Transformer

0.5-550 MHz

Outline Drawing(mm)

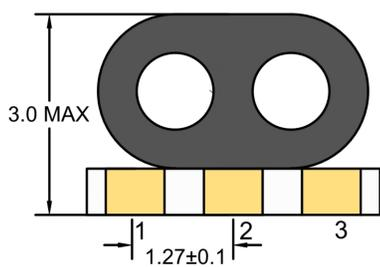
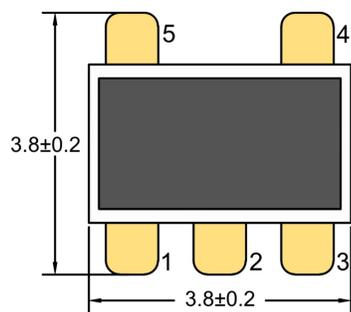

Electrical structure

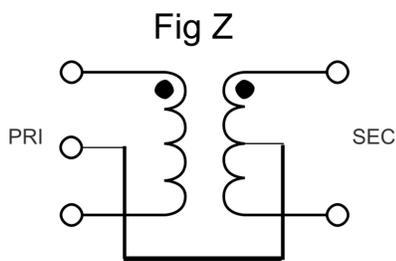

Recommended layout(mm)

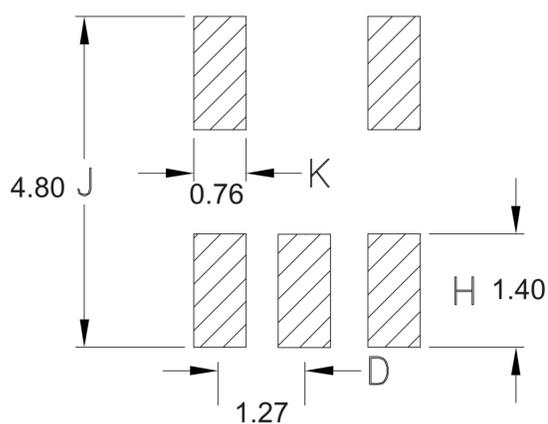

Pin Connections

Input	1
Output 1	5
Output 2	4
Ground	2, 3

Features

- RF Power, 2W Max
- DC Current, 250mA Max
- 260°C Reflow Compatible
- RoHS compliant and lead free
- Operating temperature range:-40 °C to +85 °C
- Storage temperature range: -55 °C to +100 °C

Applications

- For Motorola Walkie-talkie.
- For Car Streaming Media Rearview Mirror.
- For Broadband and Wireless Communications.
- For Wireless Microphone & Marine Communications.
- For Ideally Suited LTE, Cellular, UMTS, WiFi, WiMAX.
- For Differential Modulator/demodulator and Active Mixers.

Electrical Specifications:TA=25 °C, 0dBm, Z0=50Ω

Parameter	Test Conditions	Units	Min	Typ	Max
Main line Loss (Pin1-5)	0.5-550MHz	dB	—	0.8	1.5
Main line Loss (Pin1-4)	0.5-550MHz	dB	—	0.8	1.5
Amplitude Balance	0.5-550MHz	dB	—	1.0	1.0
Phase Balance	0.5-550MHz	°	—	2.0	5.0
Input Return Loss(Pin1)	0.5-550MHz	dB	10.0	14.0	—

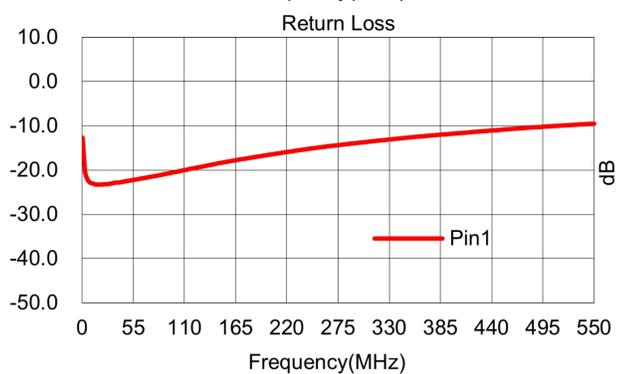
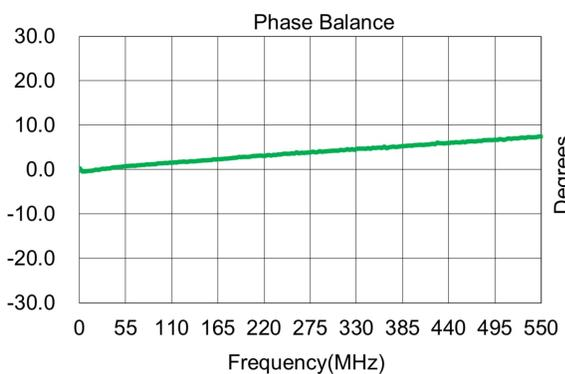
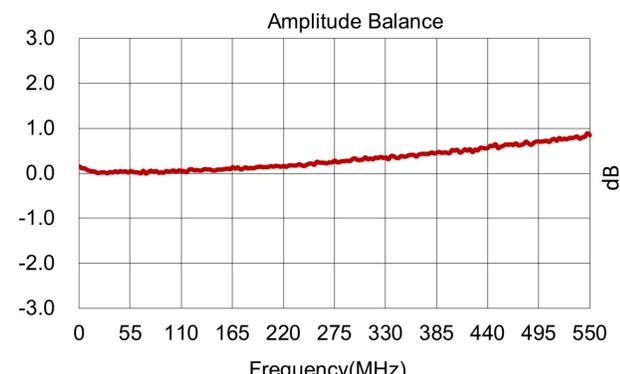
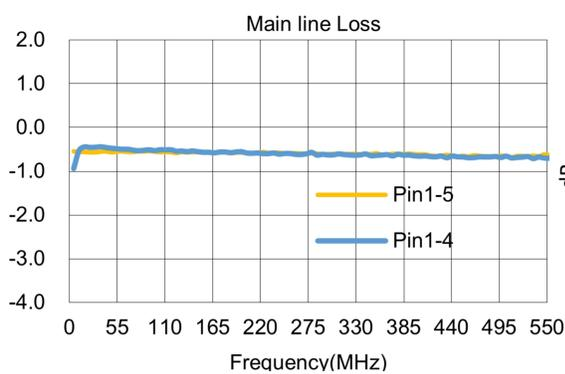

Carrier Tape Orientation

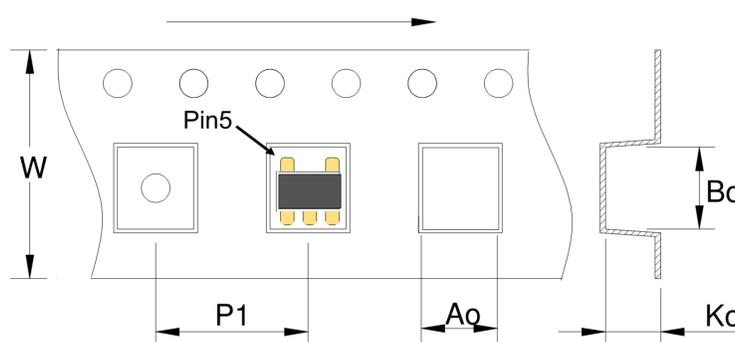

Tape & Reel Information

Parameter	Units	Value
Qty per reel	PCS	2000
Reel Size	mm	330
Tape Width	mm	12.00
Pitch	mm	8.00
Ao	mm	4.30
Bo	mm	4.30
Ko	mm	3.00