

RF Directional Coupler

HTW-009730-081

75Ω 6dB Directional Coupler

5-1200MHz



Outline Drawing(mm)

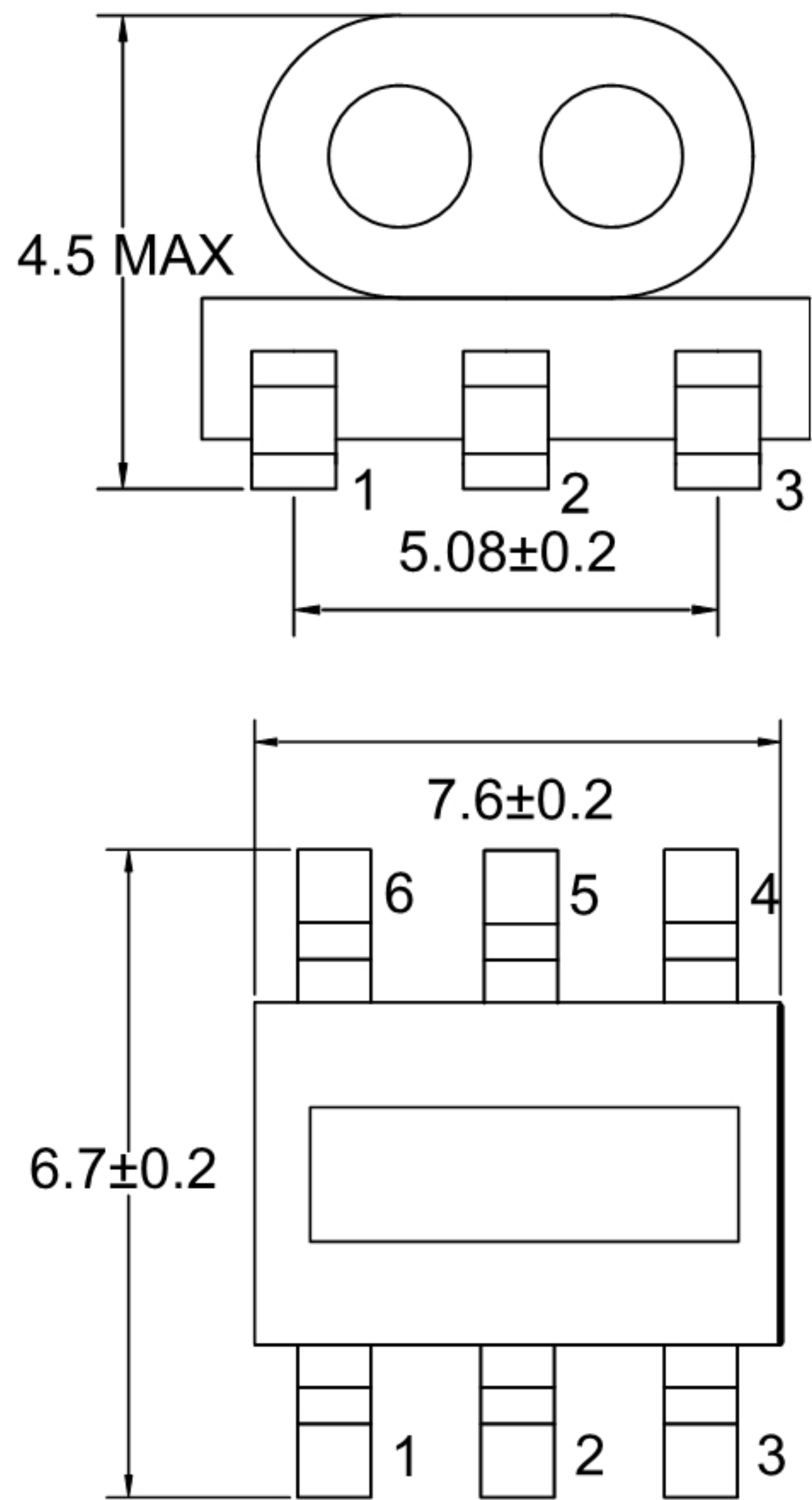

Electrical structure

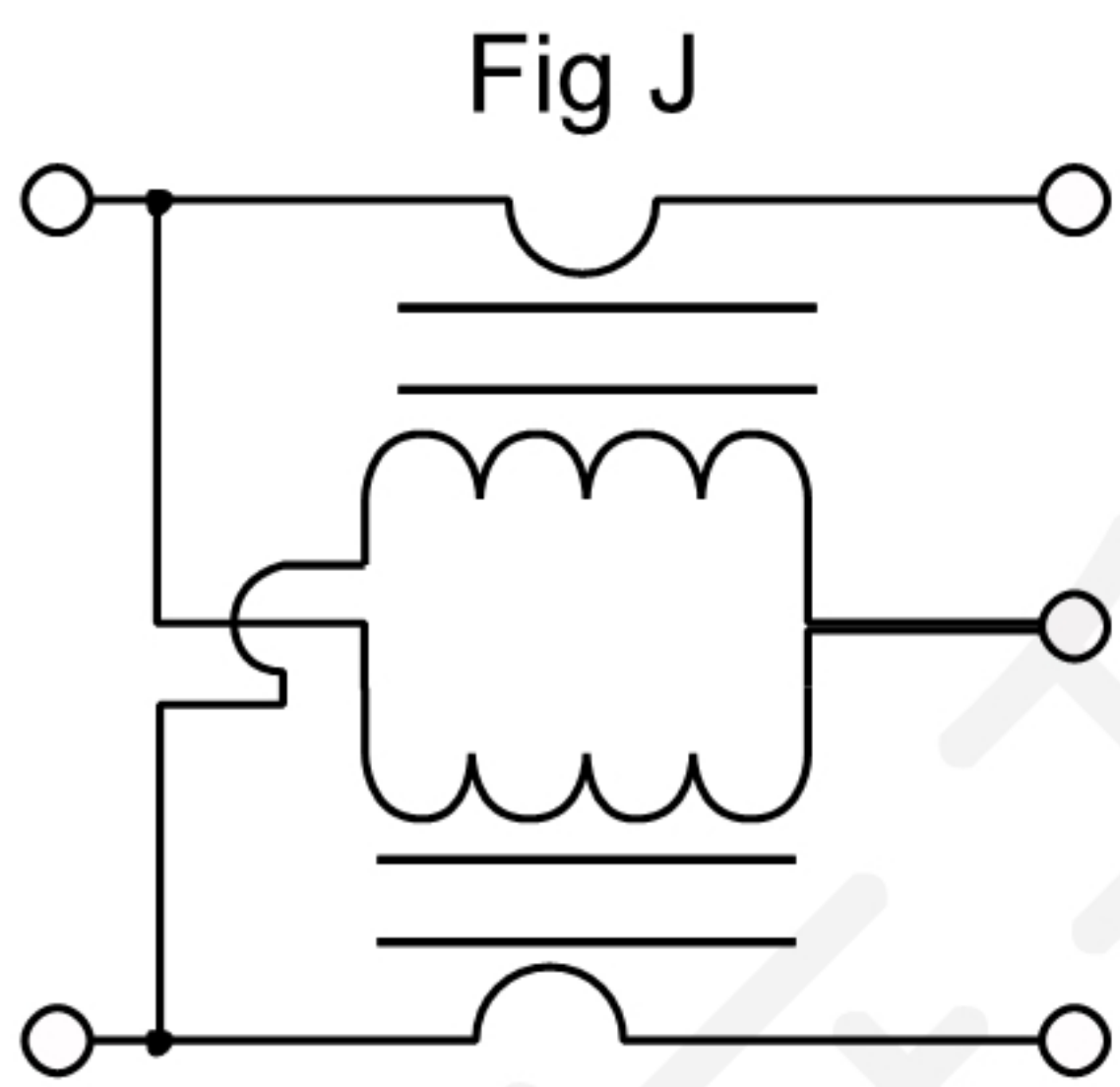

Recommended layout(mm)

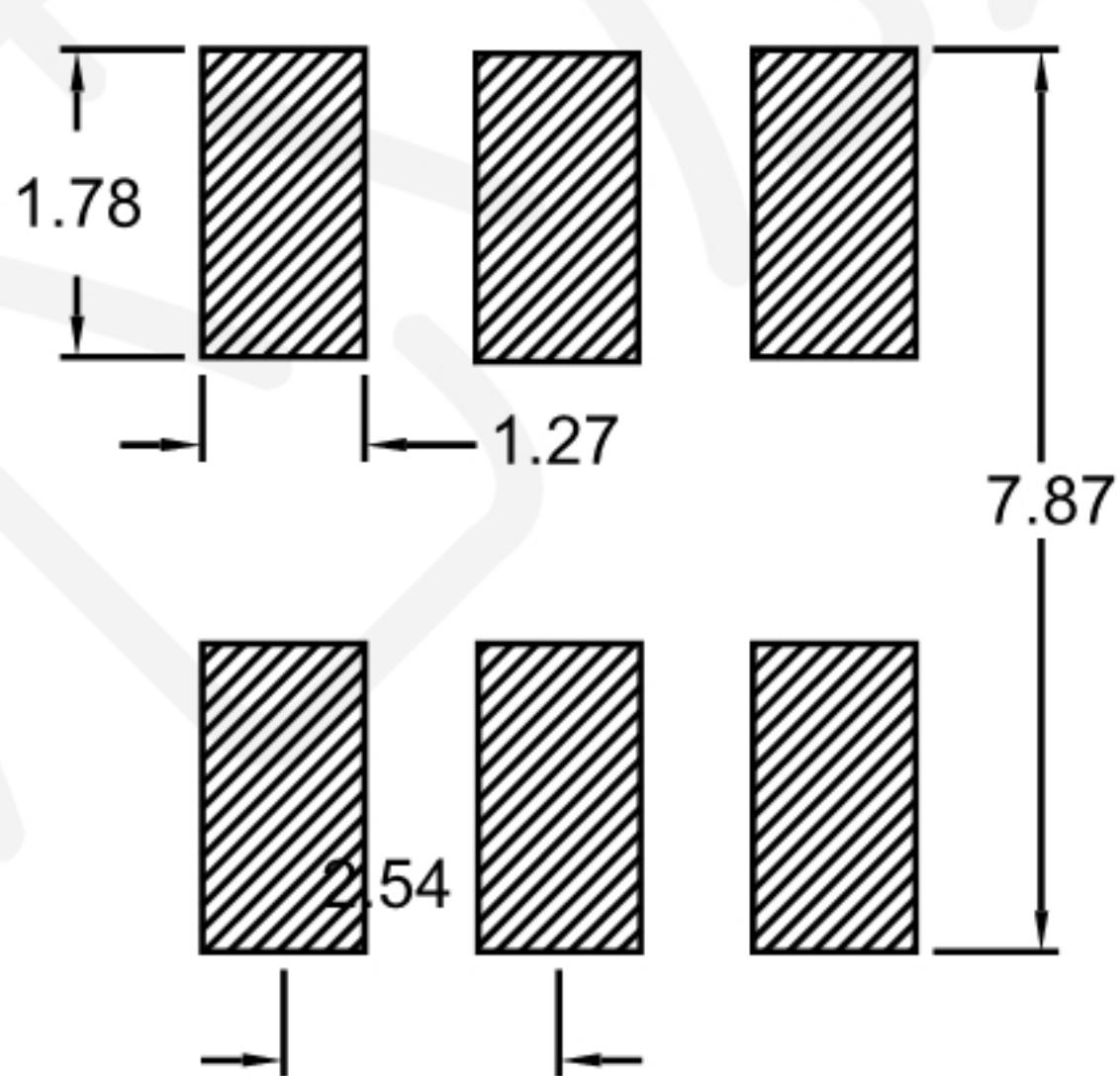

Pin Connections

Input	1
Coupling	3
Output	6
Ground	2
External 75 Ω	4

Features

- Operating temperature range: -40°C to +85°C
- Storage temperature range: -55°C to +100°C
- 260°C Reflow Compatible
- RoHS compliant and lead free
- Input Power: 250 mW
- DC Current: 30 mA

Applications

- For Docsis 3.0 & 3.1 Cable Modem.
- For Wideband Push-pull Amplifiers.
- For CATV Amplifiers Module & Set top box.
- For CATV Optical Receivers and Amplifiers.
- For VHF/UHF Transmitters and Push-pull Amplifiers.

Electrical Specifications: TA=25°C, 0dBm, Z0=75Ω

Parameter	Test Conditions	Units	Min	Typ	Max
Coupling(Pin1-3)	5-1200MHz	dB	5.0	5.8	7.0
Main line Loss(Pin1-6)	5-1200MHz	dB	—	3.5	4.2
Input Return Loss(Pin1)	5-1200MHz	dB	9.0	12.0	—
Coupling Return Loss(Pin3)	5-1200MHz	dB	8.0	10.0	—
Output Return Loss(Pin6)	5-1200MHz	dB	12.0	16.0	—
Isolation(Pin3-6)	5-1200MHz	dB	14.0	20.0	—

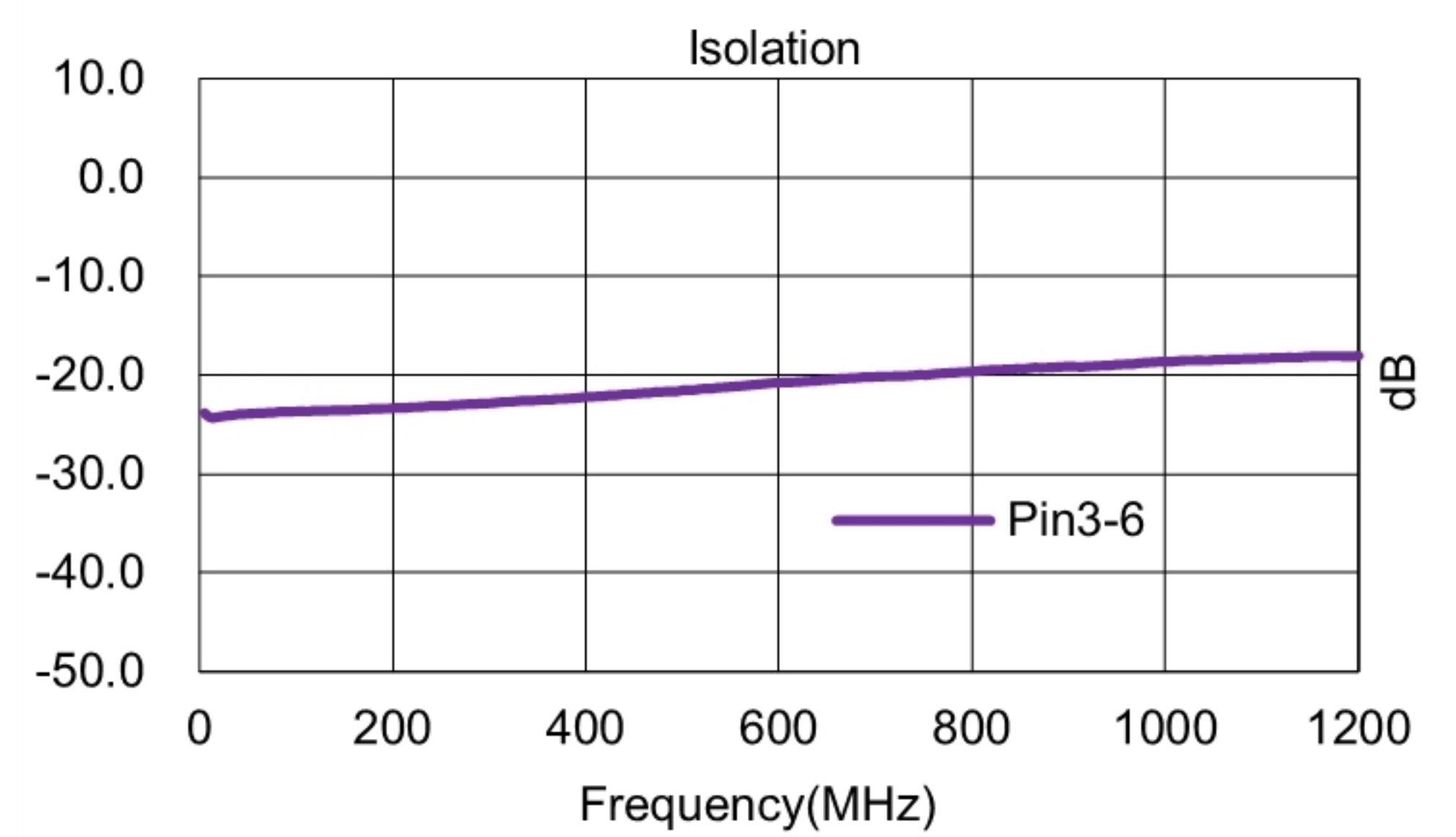
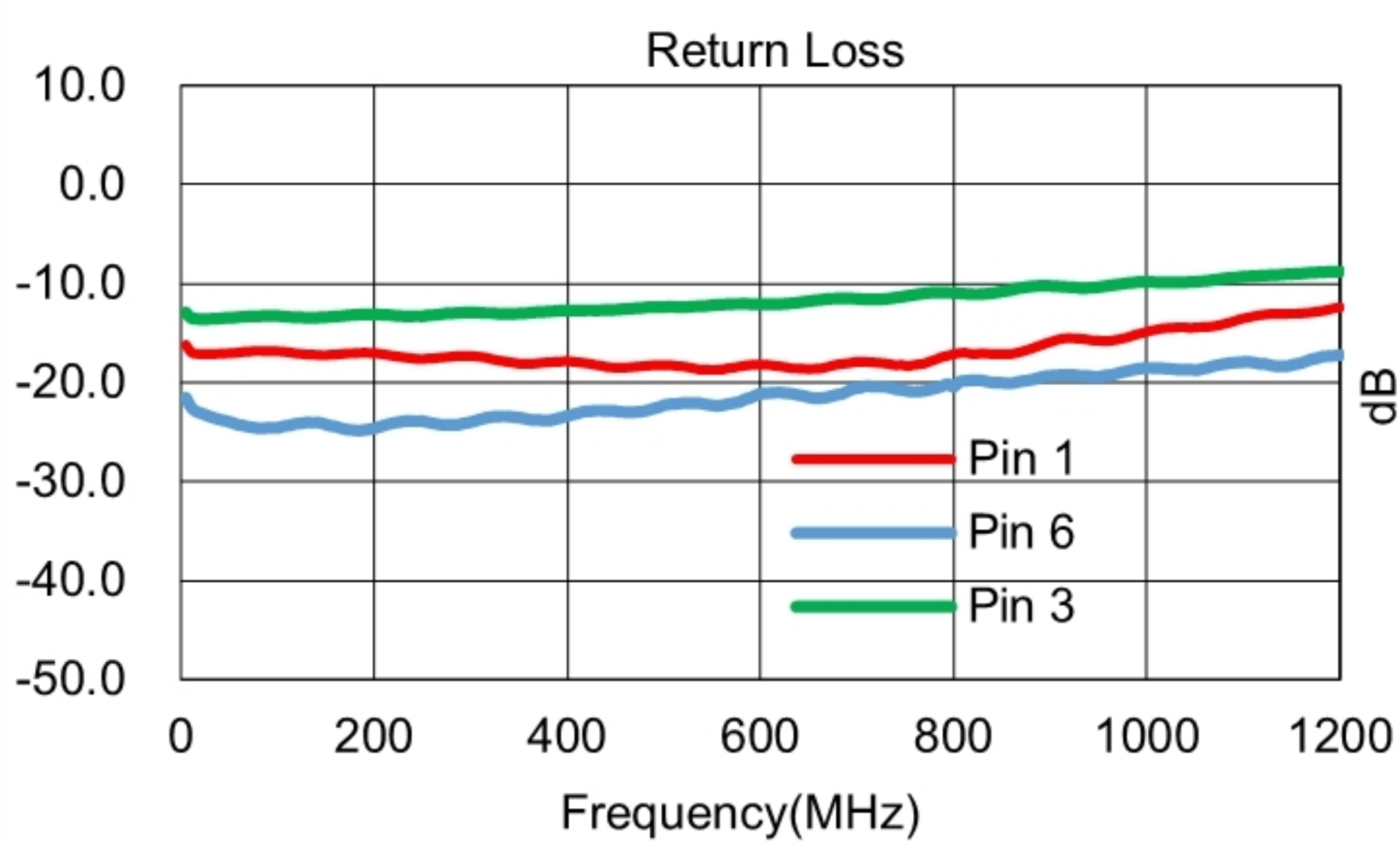
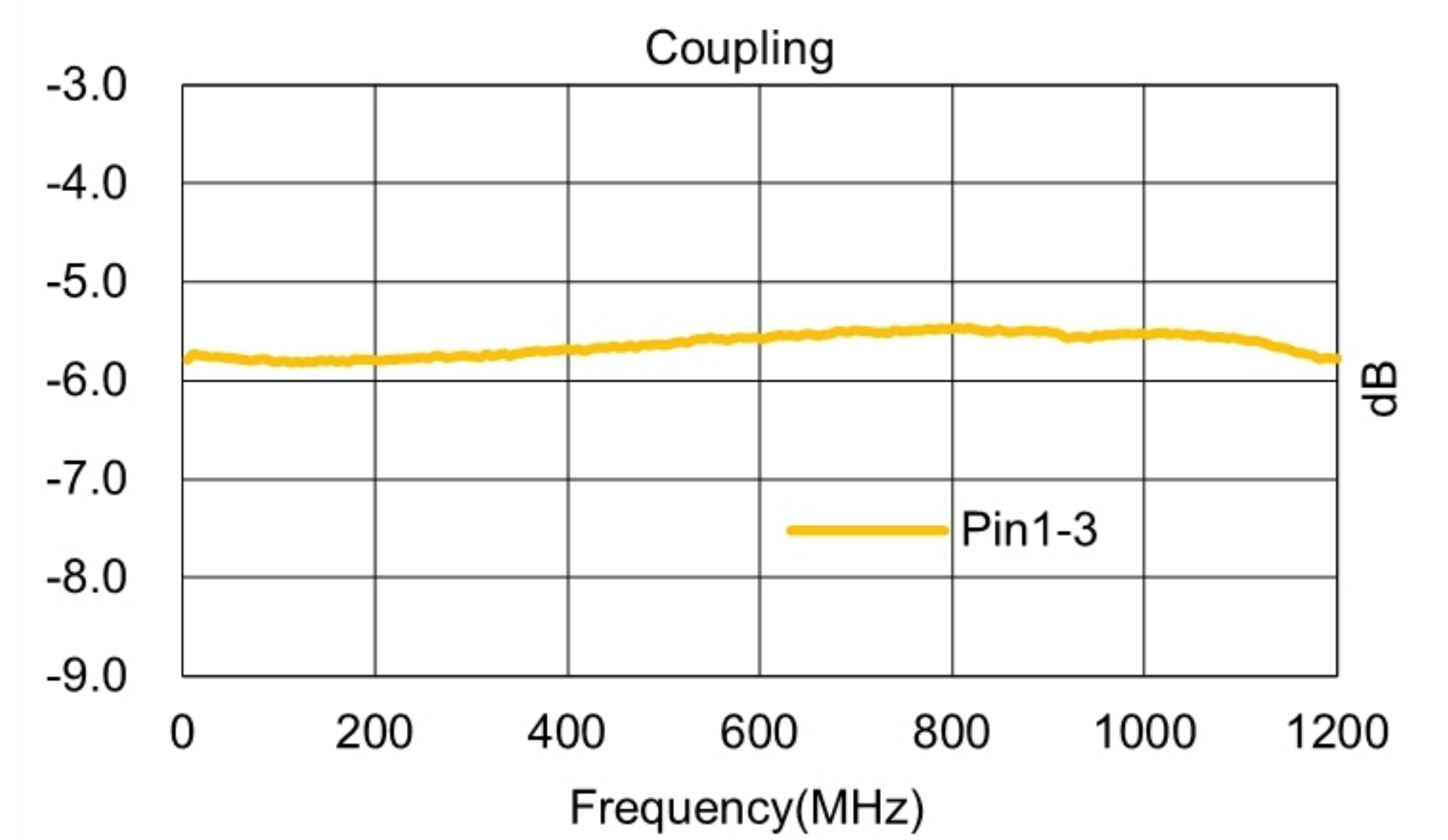
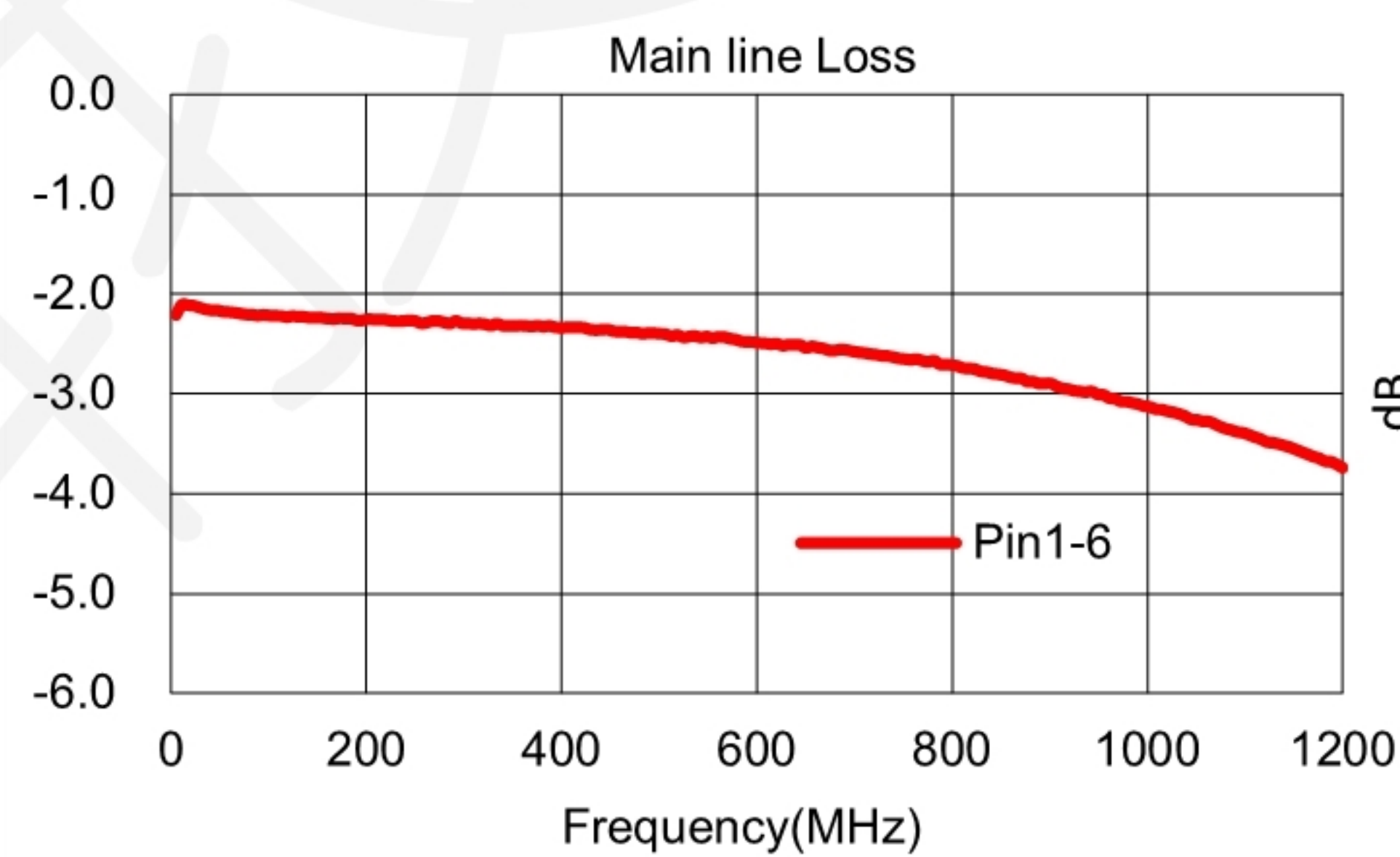

Carrier Tape Orientation

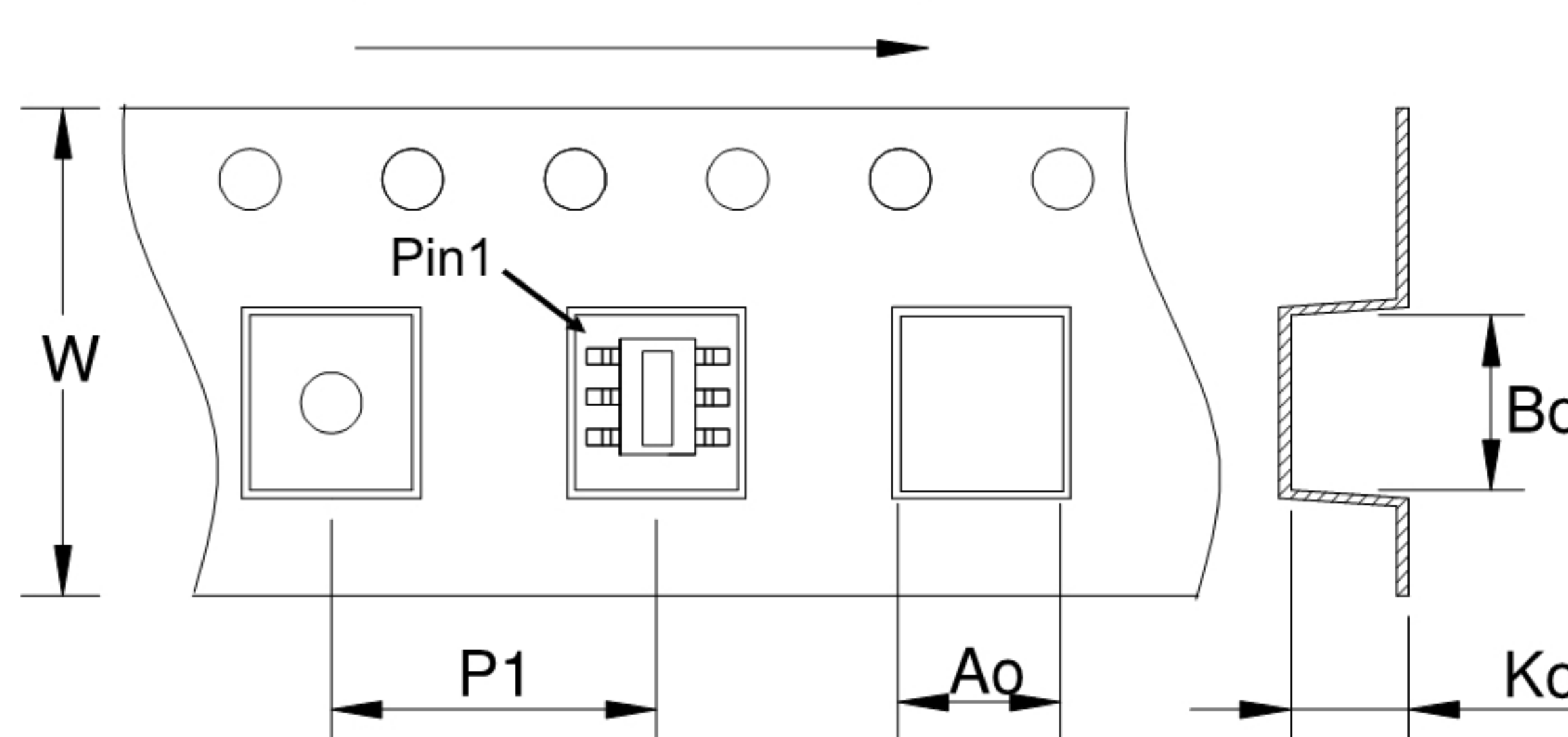

Tape & Reel Information

Parameter	Units	Value
Qty per reel	PCS	1000
Reel Size	mm	330
Tape Width	mm	24.00
Pitch	mm	12.00
Ao	mm	7.80
Bo	mm	8.50
Ko	mm	5.40