

RF Balun Transformer HTW-0201-0633

50Ω 1:1 CT Flux Coupled Transformer 3-200MHz

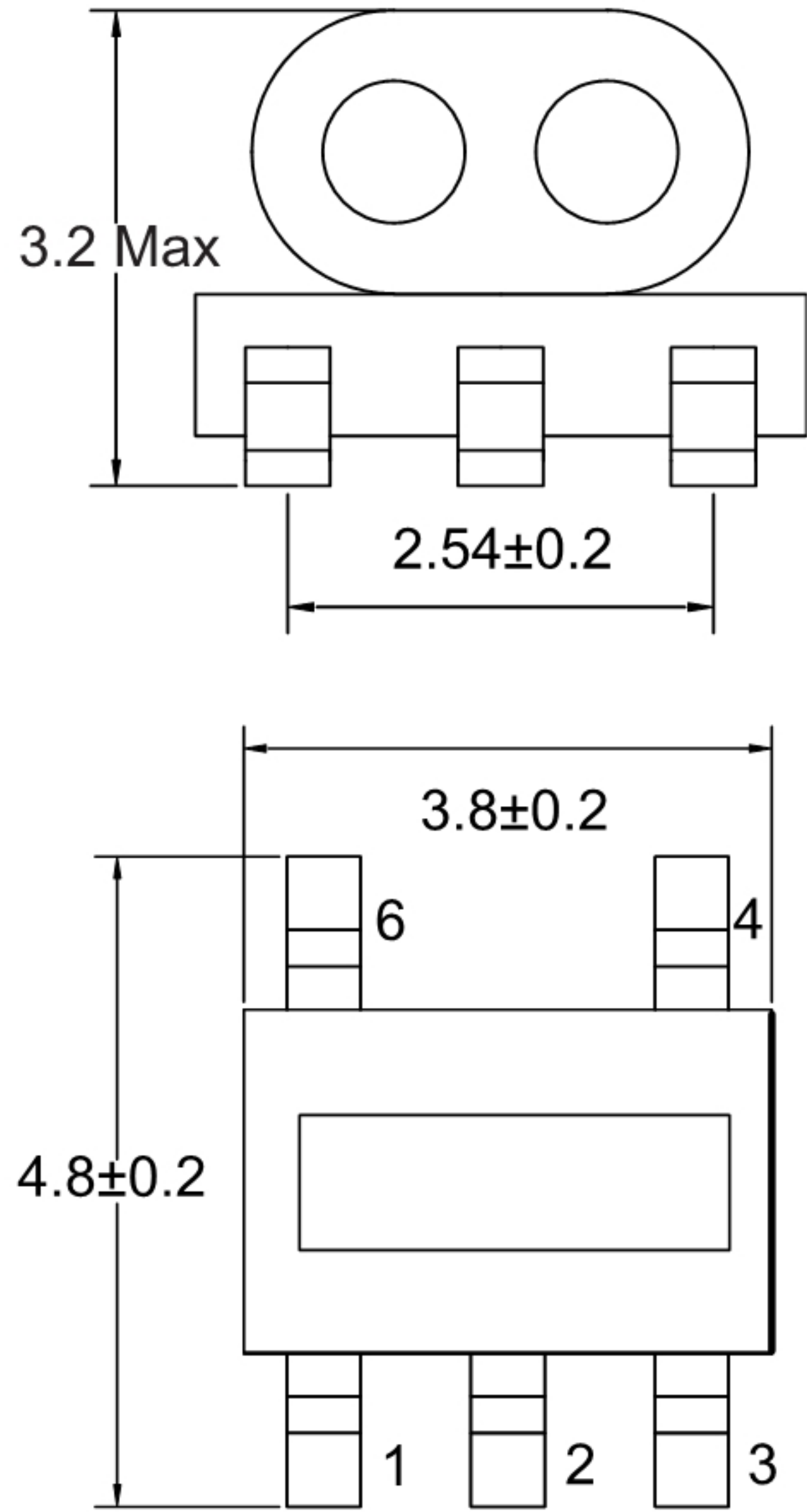

Outline Drawing(mm)



Electrical structure

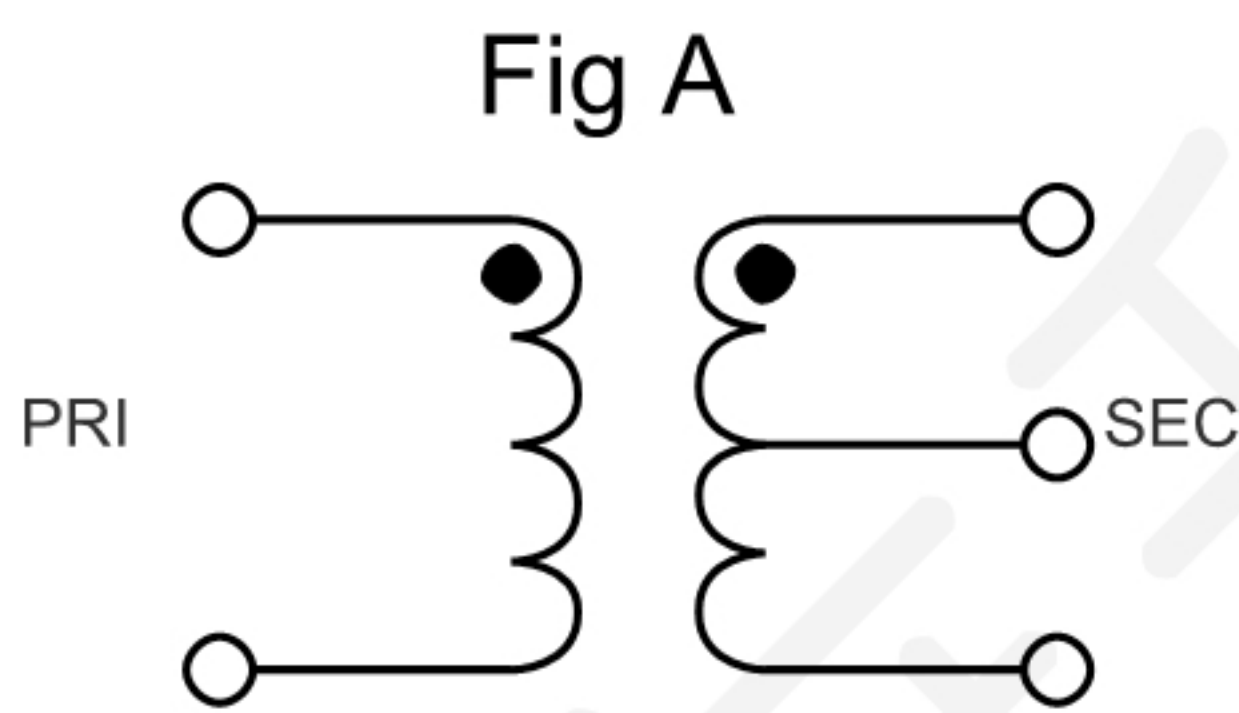

Recommended layout(mm)

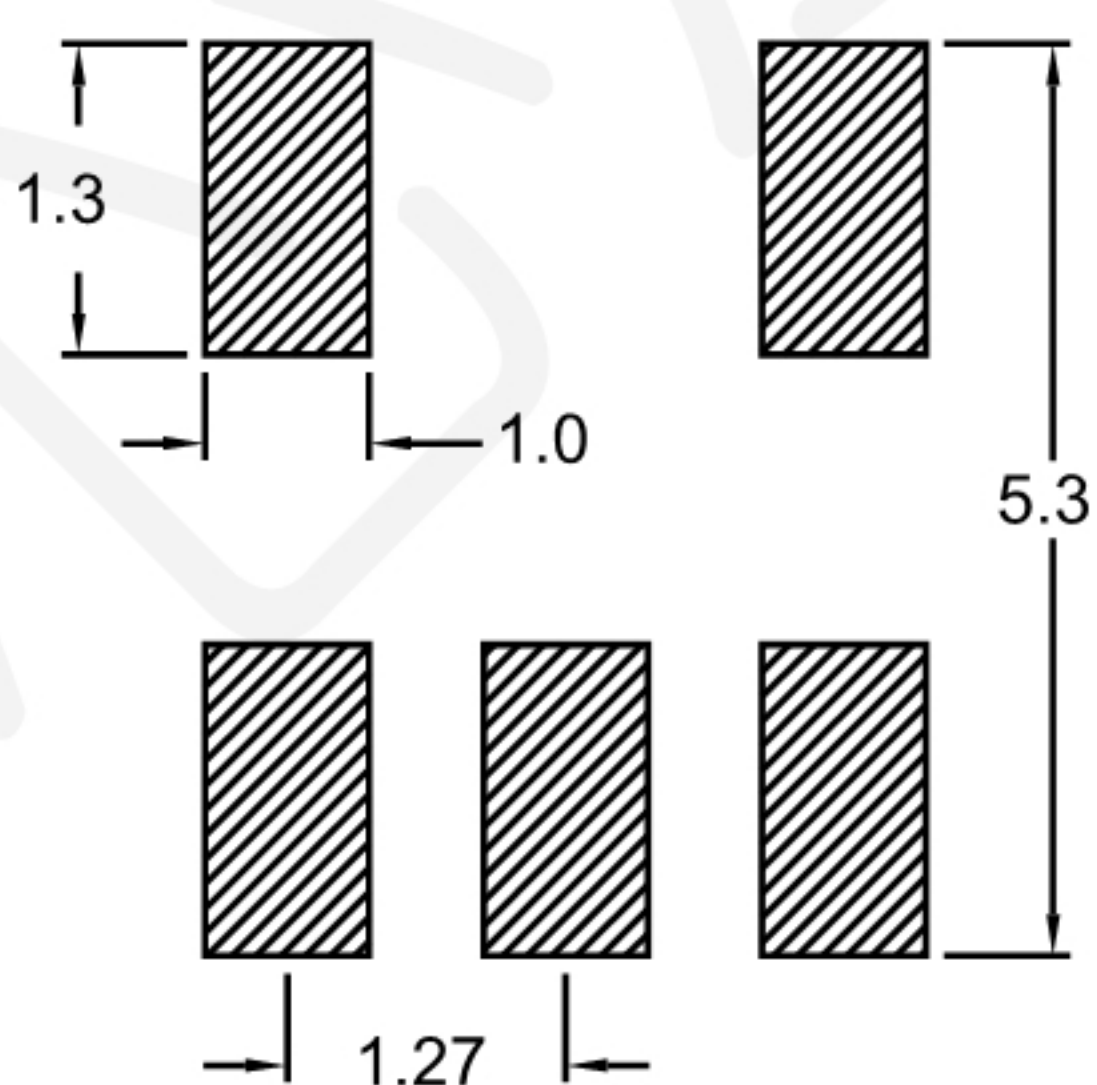

Pin Connections

Input	4
Output 1	3
Output 2	1
Ground	2, 6

Features

- Operating temperature range: -40°C to +85°C
- Storage temperature range: -55°C to +125°C
- 260°C Reflow Compatible
- RoHS compliant and lead free
- Input Power: 2.0W Max
- DC Current: 100mA Max

Applications

- For Motorola Walkie-talkie.
- For Car Streaming Media Rearview Mirror.
- For Broadband and Wireless Communications.
- For Wireless Microphone & Marine Communications.
- For Ideally Suited LTE, Cellular, UMTS, WiFi, WiMAX.
- For Differential Modulator/demodulator and Active Mixers.

Electrical Specifications: TA=25°C, 0dBm, Z0=50Ω

Parameter	Test Conditions	Units	Min	Typ	Max
Main line Loss (Pin4-3)	3-200MHz	dB	—	0.7	1.2
Main line Loss (Pin4-1)	3-200MHz	dB	—	0.6	1.0
Amplitude Balance	3-200MHz	dB	—	0.2	0.5
Phase Balance	3-200MHz	°	—	1.0	5.0
Input Return Loss(Pin4)	3-200MHz	dB	11.0	15.0	—

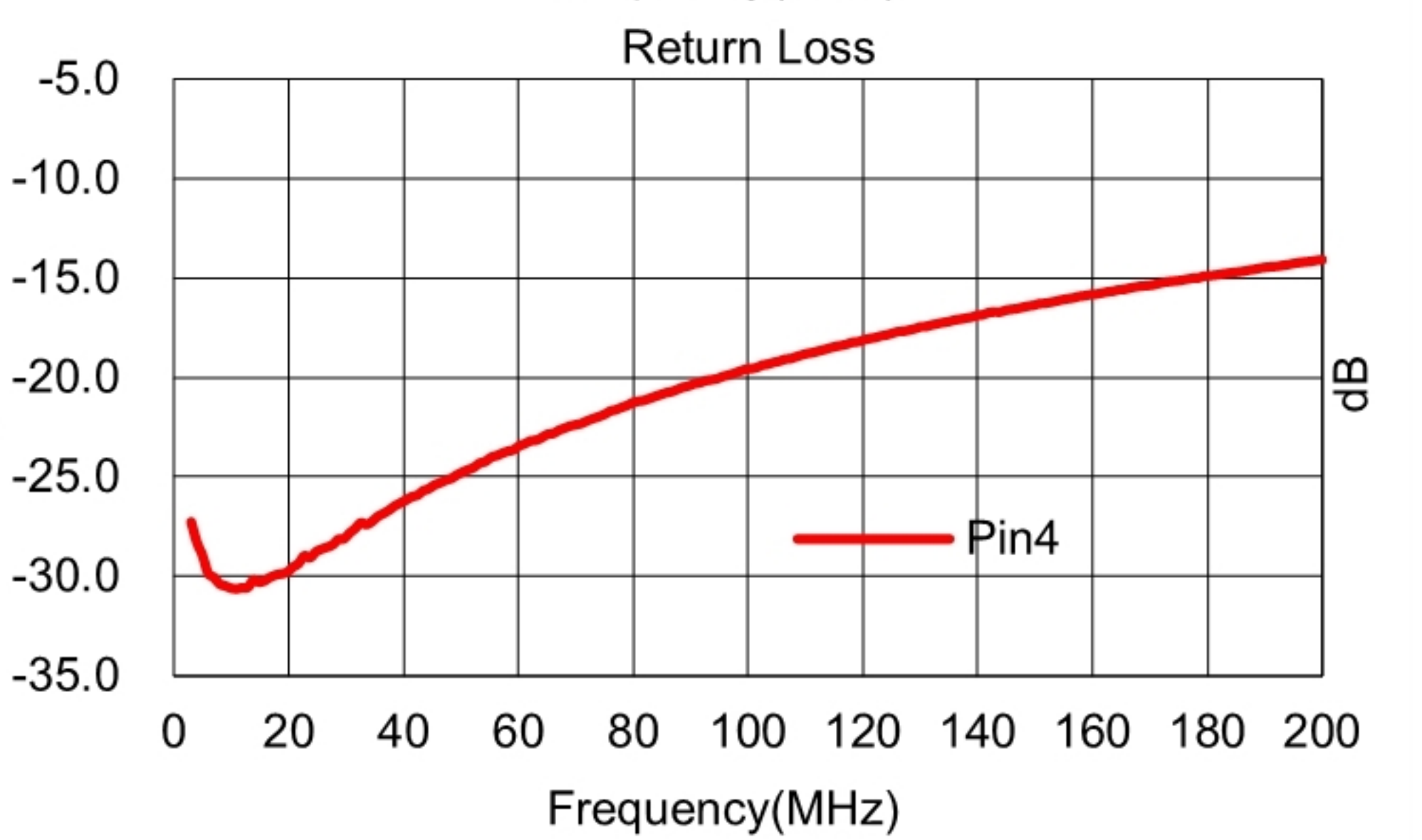
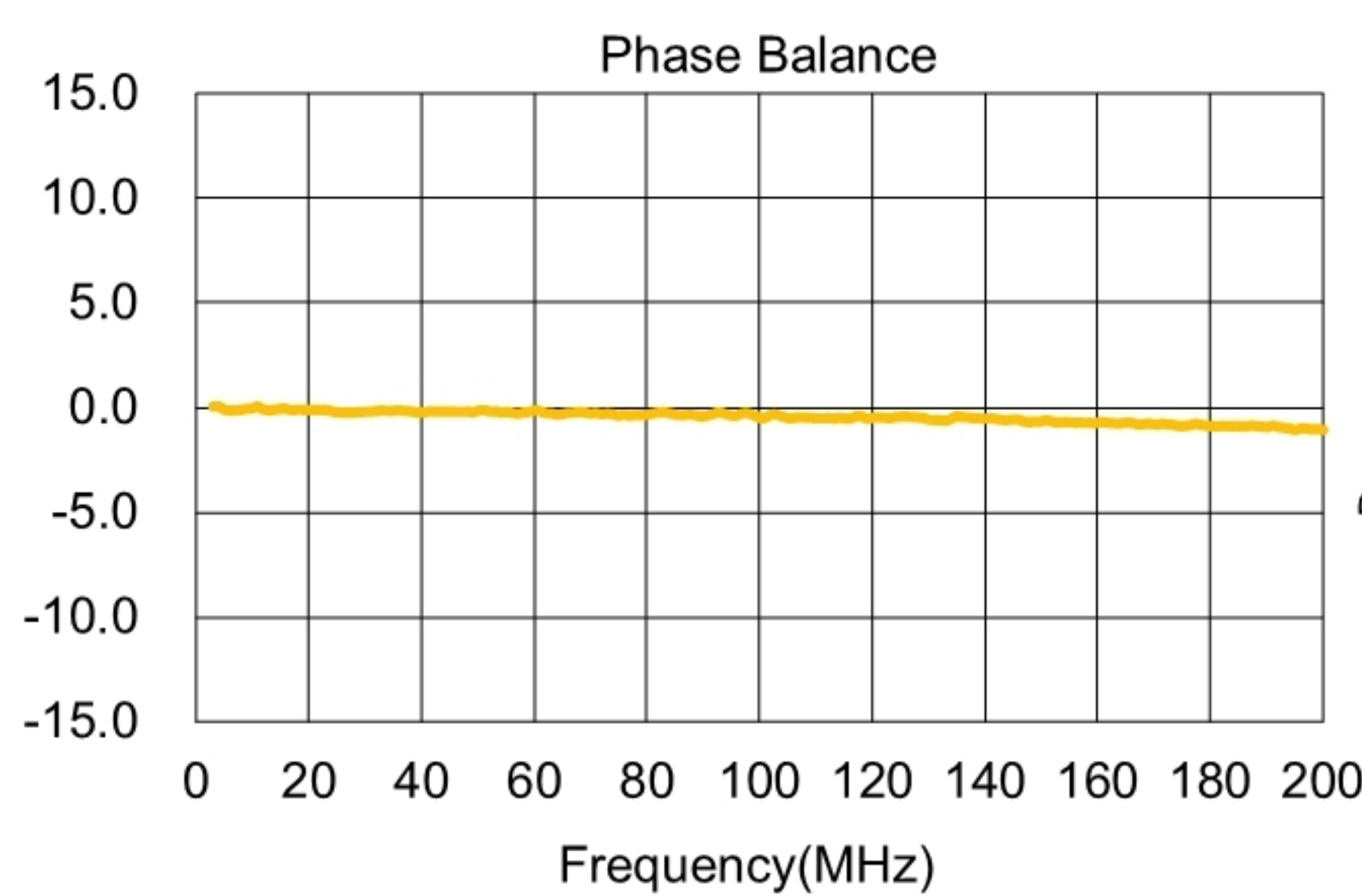
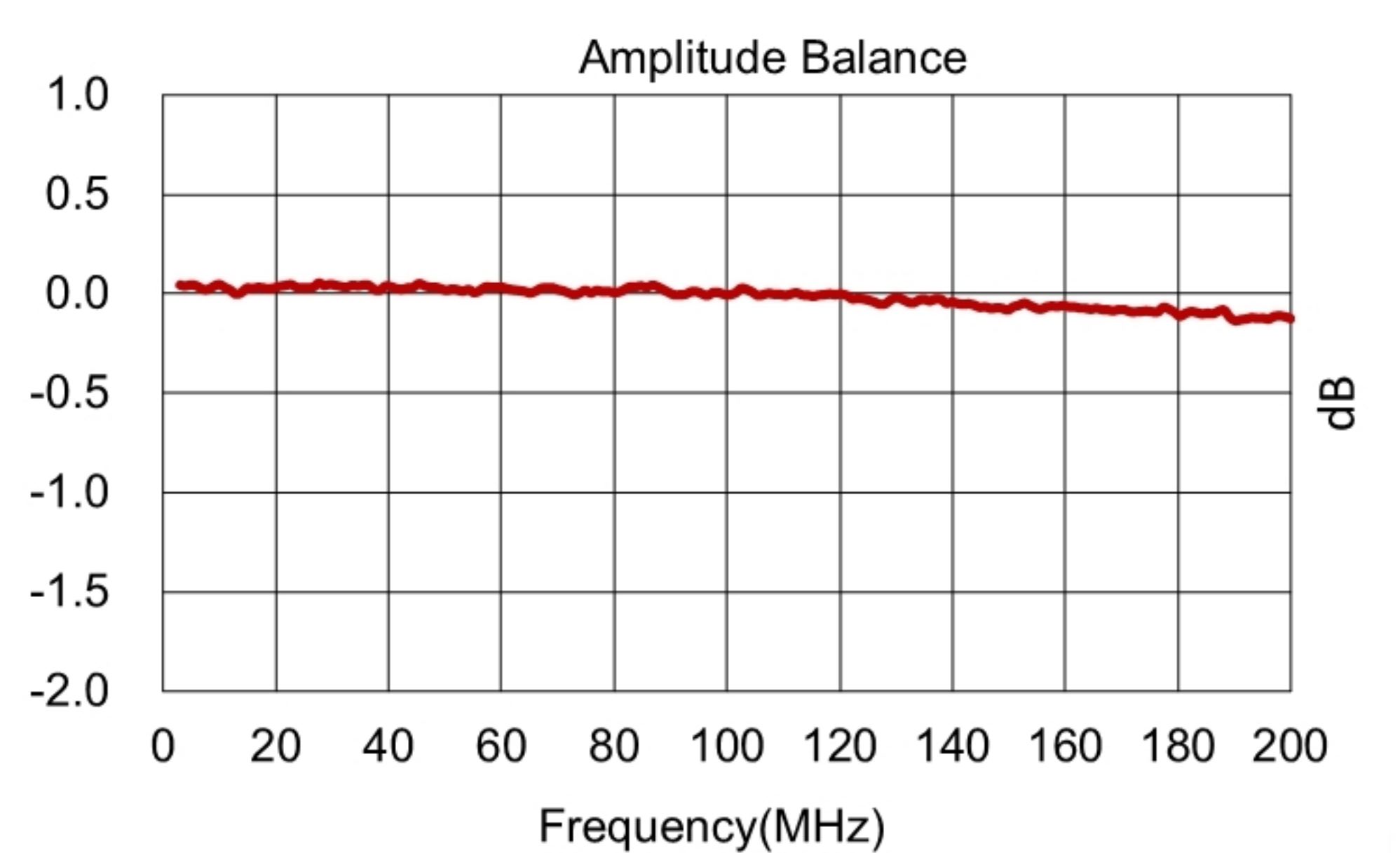
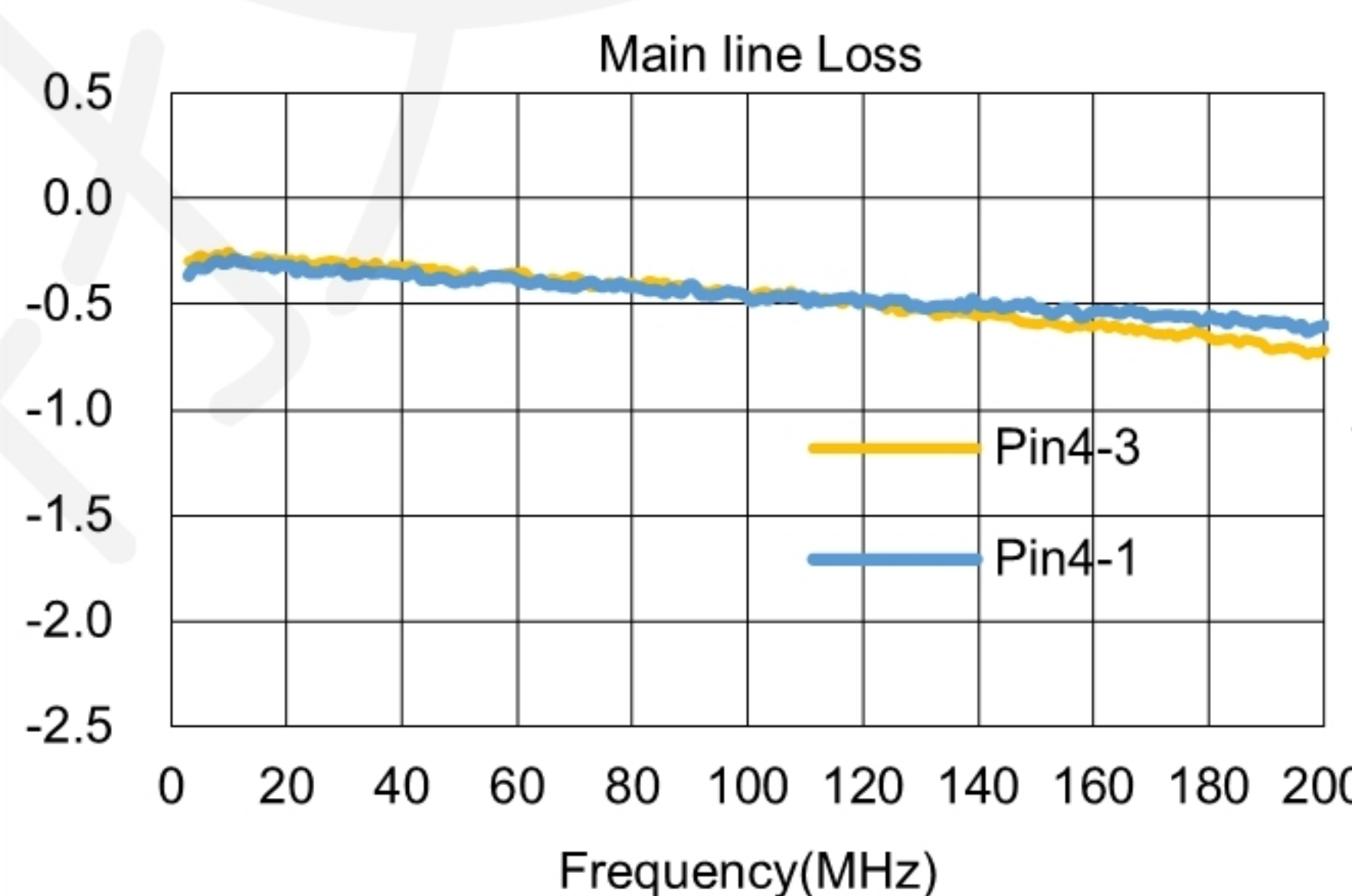

Carrier Tape Orientation

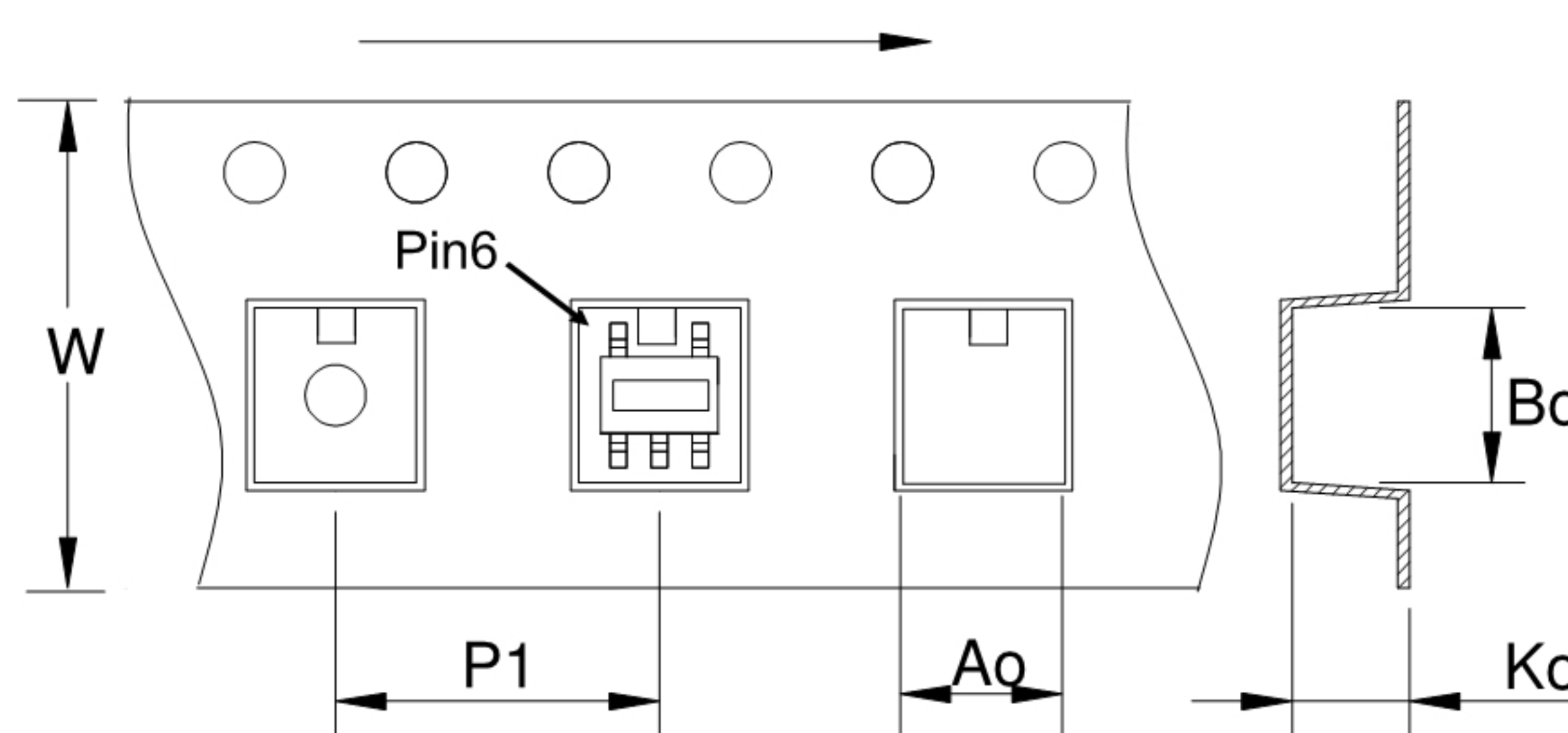

Tape & Reel Information

Parameter	Units	Value
Qty per reel	PCS	2000
Reel Size	mm	330
Tape Width	mm	12.00
Pitch	mm	8.00
Ao	mm	4.50
Bo	mm	5.70
Ko	mm	3.60